

August 1995

Features

- 3 Micron Radiation Hardened CMOS SOS
- Total Dose 200K RAD (Si)
- SEP Effective LET No Upsets: >100 MEV-cm²/mg
- Single Event Upset (SEU) Immunity < 2 x 10⁻⁹ Errors/Bit-Day (Typ)
- Dose Rate Survivability: >1 x 10¹² RAD (Si)/s
- Dose Rate Upset >10¹⁰ RAD (Si)/s 20ns Pulse
- Latch-Up Free Under Any Conditions
- Fanout (Over Temperature Range)
 - Bus Driver Outputs - 15 LSTTL Loads
- Military Temperature Range: -55°C to +125°C
- Significant Power Reduction Compared to LSTTL ICs
- DC Operating Voltage Range: 4.5V to 5.5V
- LSTTL Input Compatibility
 - VIL = 0.8V Max
 - VIH = VCC/2 Min
- Input Current Levels $I_i \leq 5\mu\text{A}$ at VOL, VOH

Description

The Intersil HCTS373MS is a Radiation Hardened octal transparent three-state latch with an active-low output enable. The outputs are transparent to the inputs when the Latch Enable ($\overline{\text{LE}}$) is HIGH. When the Latch Enable ($\overline{\text{LE}}$) goes LOW, the data is latched. The Output Enable ($\overline{\text{OE}}$) controls the three-state outputs. When the Output Enable ($\overline{\text{OE}}$) is HIGH, the outputs are in the high impedance state. The latch operation is independent of the state of the Output Enable.

The HCTS373MS utilizes advanced CMOS/SOS technology to achieve high-speed operation. This device is a member of radiation hardened, high-speed, CMOS/SOS Logic Family.

The HCTS373MS is supplied in a 20 lead Ceramic flatpack (K suffix) or a SBDIP Package (D suffix).

Pinouts

20 LEAD CERAMIC DUAL-IN-LINE
METAL SEAL PACKAGE (SBDIP)
MIL-STD-1835 CDIP2-T20
TOP VIEW

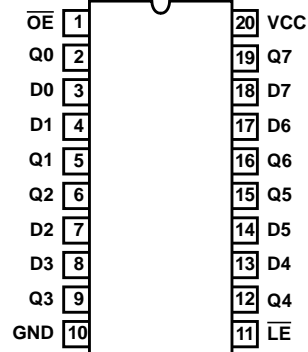

20 LEAD CERAMIC METAL SEAL
FLATPACK PACKAGE (FLATPACK)
MIL-STD-1835 CDFP4-F20
TOP VIEW

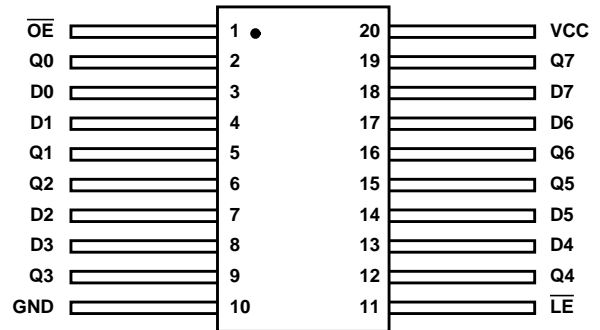

Ordering Information

| PART NUMBER | TEMPERATURE RANGE | SCREENING LEVEL | PACKAGE |
|-----------------|-------------------|-----------------------------|--------------------------|
| HCTS373DMSR | -55°C to +125°C | Intersil Class S Equivalent | 20 Lead SBDIP |
| HCTS373KMSR | -55°C to +125°C | Intersil Class S Equivalent | 20 Lead Ceramic Flatpack |
| HCTS373D/Sample | +25°C | Sample | 20 Lead SBDIP |
| HCTS373K/Sample | +25°C | Sample | 20 Lead Ceramic Flatpack |
| HCTS373HMSR | +25°C | Die | Die |

Functional Diagram

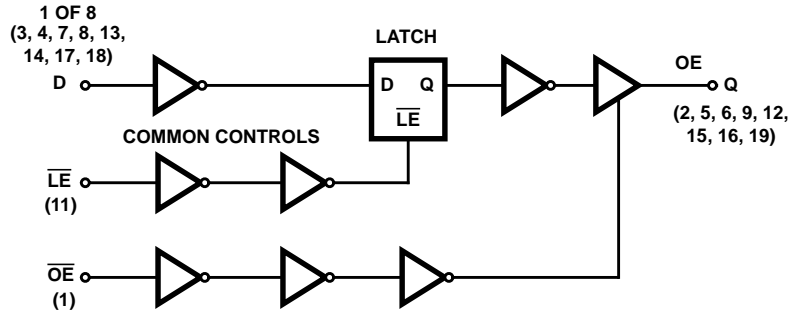

TRUTH TABLE

| \overline{OE} | \overline{LE} | D | Q |
|-----------------|-----------------|---|---|
| L | H | H | H |
| L | H | L | L |
| L | L | l | L |
| L | L | h | H |
| H | X | X | Z |

H = High Level, L = Low Level

X = Immaterial, Z = High Impedance

l = Low voltage level prior to the high-to-low latch enable transition

h = High voltage level prior to the high-to-low latch enable transition

Specifications HCTS373MS

Absolute Maximum Ratings

| | |
|---|--------------------|
| Supply Voltage (VCC) | -0.5V to +7.0V |
| Input Voltage Range, All Inputs | -0.5V to VCC +0.5V |
| DC Input Current, Any One Input | ±10mA |
| DC Drain Current, Any One Output (All Voltage Reference to the VSS Terminal) | ±25mA |
| Storage Temperature Range (TSTG) | -65°C to +150°C |
| Lead Temperature (Soldering 10sec) | +265°C |
| Junction Temperature (TJ) | +175°C |
| ESD Classification | Class 1 |

Reliability Information

| | | |
|--|---------------|---------------|
| Thermal Resistance | θ_{JA} | θ_{JC} |
| SBDIP Package | 72°C/W | 24°C/W |
| Ceramic Flatpack Package | 107°C/W | 28°C/W |
| Maximum Package Power Dissipation at +125°C Ambient | | |
| SBDIP Package | 0.69W | |
| Ceramic Flatpack Package | 0.47W | |
| If device power exceeds package dissipation capability, provide heat sinking or derate linearly at the following rate: | | |
| SBDIP Package | 13.9mW/°C | |
| Ceramic Flatpack Package | 9.3mW/°C | |

CAUTION: As with all semiconductors, stress listed under "Absolute Maximum Ratings" may be applied to devices (one at a time) without resulting in permanent damage. This is a stress rating only. Exposure to absolute maximum rating conditions for extended periods may affect device reliability. The conditions listed under "Electrical Performance Characteristics" are the only conditions recommended for satisfactory device operation.

Operating Conditions

| | | | |
|--|-----------------|--------------------------|--------------|
| Supply Voltage (VCC) | +4.5V to +5.5V | Input Low Voltage (VIL) | 0.0V to 0.8V |
| Input Rise and Fall Times at VCC = 4.5V (TR, TF) | 500ns Max | Input High Voltage (VIH) | VCC/2 to VCC |
| Operating Temperature Range (TA) | -55°C to +125°C | | |

TABLE 1. DC ELECTRICAL PERFORMANCE CHARACTERISTICS

| PARAMETER | SYMBOL | (NOTE 1) CONDITIONS | GROUP A SUB- GROUPS | TEMPERATURE | LIMITS | | UNITS |
|-----------------------------------|--------|---|---------------------------|----------------------|-------------|------|-------|
| | | | | | MIN | MAX | |
| Quiescent Current | ICC | VCC = 5.5V, VIN = VCC or GND | 1 | +25°C | - | 40 | μA |
| | | | 2, 3 | +125°C, -55°C | - | 750 | μA |
| Output Current (Sink) | IOL | VCC = 4.5V, VIH = 4.5V, VOUT = 0.4V, VIL = 0V | 1 | +25°C | 7.2 | - | mA |
| | | | 2, 3 | +125°C, -55°C | 6.0 | - | mA |
| Output Current (Source) | IOH | VCC = 4.5V, VIH = 4.5V, VOUT = VCC - 0.4V, VIL = 0V | 1 | +25°C | -7.2 | - | mA |
| | | | 2, 3 | +125°C, -55°C | -6.0 | - | mA |
| Output Voltage Low | VOL | VCC = 4.5V, VIH = 2.25V, IOL = 50μA, VIL = 0.8V | 1, 2, 3 | +25°C, +125°C, -55°C | - | 0.1 | V |
| | | VCC = 5.5V, VIH = 2.75V, IOL = 50μA, VIL = 0.8V | 1, 2, 3 | +25°C, +125°C, -55°C | - | 0.1 | V |
| Output Voltage High | VOH | VCC = 4.5V, VIH = 2.25V, IOH = -50μA, VIL = 0.8V | 1, 2, 3 | +25°C, +125°C, -55°C | VCC -0.1 | - | V |
| | | VCC = 5.5V, VIH = 2.75V, IOH = -50μA, VIL = 0.8V | 1, 2, 3 | +25°C, +125°C, -55°C | VCC -0.1 | - | V |
| Input Leakage Current | IIN | VCC = 5.5V, VIN = VCC or GND | 1 | +25°C | - | ±0.5 | μA |
| | | | 2, 3 | +125°C, -55°C | - | ±5.0 | μA |
| Output Tri State Leakage | IOZ | VCC = 5.5V, VO = 0V or VCC | 1 | +25°C | - | ±1.0 | μA |
| | | | 2, 3 | +125°C, -55°C | | ±50 | μA |
| Noise Immunity Functional Test | FN | VCC = 4.5V, VIH = 2.25V, VIL = 0.8V (Note 2) | 7, 8A, 8B | +25°C, +125°C, -55°C | - | - | - |

NOTES:

1. All voltages reference to device GND.
2. For functional tests VO ≥ 4.0V is recognized as a logic "1", and VO ≤ 0.5V is recognized as a logic "0".

Specifications HCTS373MS

TABLE 2. AC ELECTRICAL PERFORMANCE CHARACTERISTICS

| PARAMETER | SYMBOL | (NOTES 1, 2) CONDITIONS | GROUP A SUB- GROUPS | TEMPERATURE | LIMITS | | UNITS |
|-----------------------|---------------|----------------------------|---------------------------|---------------|--------|-----|-------|
| | | | | | MIN | MAX | |
| Data to Qn | TPLH | VCC = 4.5V | 9 | +25°C | 2 | 19 | ns |
| | | | 10, 11 | +125°C, -55°C | 2 | 24 | ns |
| | TPHL | VCC = 4.5V | 9 | +25°C | 2 | 26 | ns |
| | | | 10, 11 | +125°C, -55°C | 2 | 30 | ns |
| \overline{LE} to Qn | TPLH | VCC = 4.5V | 9 | +25°C | 2 | 27 | ns |
| | | | 10, 11 | +125°C, -55°C | 2 | 30 | ns |
| | TPHL | VCC = 4.5V | 9 | +25°C | 2 | 30 | ns |
| | | | 10, 11 | +125°C, -55°C | 2 | 34 | ns |
| Enable to Output | TPZL | VCC = 4.5V | 9 | +25°C | 2 | 32 | ns |
| | | | 10, 11 | +125°C, -55°C | 2 | 36 | ns |
| | TPZH | VCC = 4.5V | 9 | +25°C | 2 | 26 | ns |
| | | | 10, 11 | +125°C, -55°C | 2 | 29 | ns |
| Disable to Output | TPLZ, TPHZ | VCC = 4.5V | 9 | +25°C | 2 | 22 | ns |
| | | | 10, 11 | +125°C, -55°C | 2 | 25 | ns |

NOTES:

1. All voltages referenced to device GND.
2. AC measurements assume $R_L = 500\Omega$, $C_L = 50pF$, Input $T_R = T_F = 3ns$, $V_{IL} = GND$, $V_{IH} = 3V$.

TABLE 3. ELECTRICAL PERFORMANCE CHARACTERISTICS

| PARAMETER | SYMBOL | CONDITIONS | NOTES | TEMPERATURE | LIMITS | | UNITS |
|------------------------------------|--------------|----------------------|-------|---------------|--------|-----|-------|
| | | | | | MIN | MAX | |
| Capacitance Power Dissipation | CPD | VCC = 5.0V, f = 1MHz | 1 | +25°C | - | 57 | pF |
| | | | 1 | +125°C, -55°C | - | 57 | pF |
| Input Capacitance | CIN | VCC = 5.0V, f = 1MHz | 1 | +25°C | - | 10 | pF |
| | | | 1 | +125°C, -55°C | - | 10 | pF |
| Output Transition Time | TTHL TTLH | VCC = 4.5V | 1 | +25°C | - | 12 | ns |
| | | | 1 | +125°C, -55°C | - | 18 | ns |
| Setup Time Data to \overline{LE} | TSU | VCC = 4.5V | 1 | +25°C | 13 | - | ns |
| | | | 1 | +125°C, -55°C | 20 | - | ns |
| Hold Time Data to \overline{LE} | TH | VCC = 4.5V | 1 | +25°C | 10 | - | ns |
| | | | 1 | +125°C, -55°C | 15 | - | ns |
| Pulse Width \overline{LE} | TW | VCC = 4.5V | 1 | +25°C | 16 | - | ns |
| | | | 1 | +125°C, -55°C | 24 | - | ns |

NOTE:

1. The parameters listed in Table 3 are controlled via design or process parameters. Min and Max Limits are guaranteed but not directly tested. These parameters are characterized upon initial design release and upon design changes which affect these characteristics.

Specifications HCTS373MS

TABLE 4. DC POST RADIATION ELECTRICAL PERFORMANCE CHARACTERISTICS

| PARAMETER | SYMBOL | (NOTES 1, 2) CONDITIONS | TEMPERATURE | 200K RAD LIMITS | | UNITS |
|---------------------------------------|---------------|--|-------------|--------------------|------|-------|
| | | | | MIN | MAX | |
| Quiescent Current | ICC | VCC = 5.5V, VIN = VCC or GND | +25°C | - | 0.75 | mA |
| Output Current (Sink) | IOL | VCC = 4.5V, VIN = VCC or GND, VOUT = 0.4V | +25°C | 6.0 | - | mA |
| Output Current (Source) | IOH | VCC = 4.5V, VIN = VCC or GND, VOUT = VCC - 0.4V | +25°C | -6.0 | - | mA |
| Output Voltage Low | VOL | VCC = 4.5V and 5.5V, VIH = VCC/2, VIL = 0.8V, IOL = 50µA | +25°C | - | 0.1 | V |
| Output Voltage High | VOH | VCC = 4.5V and 5.5V, VIH = VCC/2, VIL = 0.8V, IOH = -50µA | +25°C | VCC -0.1 | - | V |
| Input Leakage Current | IIN | VCC = 5.5V, VIN = VCC or GND | +25°C | - | ±5 | µA |
| Three-State Output Leakage Current | IOZ | Applied Voltage = 0V or VCC, VCC = 5.5V | +25°C | - | ±50 | µA |
| Noise Immunity Functional Test | FN | VCC = 4.5V, VIH = 2.25V, VIL = 0.8V, (Note 3) | +25°C | - | - | - |
| Data to Qn | TPLH | VCC = 4.5V | +25°C | 2 | 24 | ns |
| | TPHL | VCC = 4.5V | +25°C | 2 | 30 | ns |
| LE to Qn | TPLH | VCC = 4.5V | +25°C | 2 | 30 | ns |
| | TPHL | VCC = 4.5V | +25°C | 2 | 34 | ns |
| Enable to Output | TPZL | VCC = 4.5V | +25°C | 2 | 36 | ns |
| | TPZH | VCC = 4.5V | +25°C | 2 | 29 | ns |
| Disable to Output | TPLZ, TPHZ | VCC = 4.5V | +25°C | 2 | 25 | ns |

NOTES:

1. All voltages referenced to device GND.
2. AC measurements assume RL = 500Ω, CL = 50pF, Input TR = TF = 3ns, VIL = GND, VIH = 3V.
3. For functional tests VO ≥ 4.0V is recognized as a logic "1", and VO ≤ 0.5V is recognized as a logic "0".

TABLE 5. BURN-IN AND OPERATING LIFE TEST, DELTA PARAMETERS (+25°C)

| PARAMETER | GROUP B SUBGROUP | DELTA LIMIT |
|-----------|---------------------|----------------|
| ICC | 5 | 12µA |
| IOL/IOH | 5 | -15% of 0 Hour |
| IOZL/IOZH | 5 | ±200nA |

Specifications HCTS373MS

TABLE 6. APPLICABLE SUBGROUPS

| CONFORMANCE GROUPS | | METHOD | GROUP A SUBGROUPS | READ AND RECORD |
|--------------------------------|--------------|-------------|---------------------------------------|------------------------------|
| Initial Test (Preburn-In) | | 100%/5004 | 1, 7, 9 | ICC, IOL/H |
| Interim Test I (Postburn-In) | | 100%/5004 | 1, 7, 9 | ICC, IOL/H |
| Interim Test II (Postburn-In) | | 100%/5004 | 1, 7, 9 | ICC, IOL/H |
| PDA | | 100%/5004 | 1, 7, 9, Deltas | |
| Interim Test III (Postburn-In) | | 100%/5004 | 1, 7, 9 | ICC, IOL/H |
| PDA | | 100%/5004 | 1, 7, 9, Deltas | |
| Final Test | | 100%/5004 | 2, 3, 8A, 8B, 10, 11 | |
| Group A (Note 1) | | Sample/5005 | 1, 2, 3, 7, 8A, 8B, 9, 10, 11 | |
| Group B | Subgroup B-5 | Sample/5005 | 1, 2, 3, 7, 8A, 8B, 9, 10, 11, Deltas | Subgroups 1, 2, 3, 9, 10, 11 |
| | Subgroup B-6 | Sample/5005 | 1, 7, 9 | |
| Group D | | Sample/5005 | 1, 7, 9 | |

NOTE:

1. Alternate Group A testing in accordance with method 5005 of MIL-STD-883 may be exercised.

TABLE 7. TOTAL DOSE IRRADIATION

| CONFORMANCE GROUPS | METHOD | TEST | | READ AND RECORD | |
|--------------------|--------|---------|----------|-----------------|------------------|
| | | PRE RAD | POST RAD | PRE RAD | POST RAD |
| Group E Subgroup 2 | 5005 | 1, 7, 9 | Table 4 | 1, 9 | Table 4 (Note 1) |

NOTE:

1. Except FN test which will be performed 100% Go/No-Go.

TABLE 8. STATIC AND DYNAMIC BURN-IN TEST CONNECTIONS

| OPEN | GROUND | 1/2 VCC = 3V ± 0.5V | VCC = 6V ± 0.5V | OSCILLATOR | |
|---|---------------------------------------|----------------------------|---------------------------------------|------------|----------------------------|
| | | | | 50kHz | 25kHz |
| STATIC BURN-IN I TEST CONNECTIONS (Note 1) | | | | | |
| 2, 5, 6, 9, 12, 15, 16, 19 | 1, 3, 4, 7, 8, 10, 11, 13, 14, 17, 18 | - | 20 | - | - |
| STATIC BURN-IN II TEST CONNECTIONS (Note 1) | | | | | |
| 2, 5, 6, 9, 12, 15, 16, 19 | 10 | - | 1, 3, 4, 7, 8, 11, 13, 14, 17, 18, 20 | - | - |
| DYNAMIC BURN-IN TEST CONNECTIONS (Note 2) | | | | | |
| - | 1, 10 | 2, 5, 6, 9, 12, 15, 16, 19 | 20 | 11 | 3, 4, 7, 8, 13, 14, 17, 18 |

NOTES:

1. Each pin except VCC and GND will have a resistor of 10kΩ ± 5% for static burn-in
2. Each pin except VCC and GND will have a resistor of 680Ω ± 5% for dynamic burn-in

TABLE 9. IRRADIATION TEST CONNECTIONS

| OPEN | GROUND | VCC = 5V ± 0.5V |
|----------------------------|--------|---------------------------------------|
| 2, 5, 6, 9, 12, 15, 16, 19 | 10 | 1, 3, 4, 7, 8, 11, 13, 14, 17, 18, 20 |

NOTE: Each pin except VCC and GND will have a resistor of 47kΩ ± 5% for irradiation testing. Group E, Subgroup 2, sample size is 4 dice/wafer 0 failures.

HCTS373MS

Intersil Space Level Product Flow - 'MS'

| | |
|--|--|
| Wafer Lot Acceptance (All Lots) Method 5007 (Includes SEM) | 100% Interim Electrical Test 1 (T1) |
| GAMMA Radiation Verification (Each Wafer) Method 1019, 4 Samples/Wafer, 0 Rejects | 100% Delta Calculation (T0-T1) |
| 100% Nondestructive Bond Pull, Method 2023 | 100% Static Burn-In 2, Condition A or B, 24 hrs. min., +125°C min., Method 1015 |
| Sample - Wire Bond Pull Monitor, Method 2011 | 100% Interim Electrical Test 2 (T2) |
| Sample - Die Shear Monitor, Method 2019 or 2027 | 100% Delta Calculation (T0-T2) |
| 100% Internal Visual Inspection, Method 2010, Condition A | 100% PDA 1, Method 5004 (Notes 1 and 2) |
| 100% Temperature Cycle, Method 1010, Condition C, 10 Cycles | 100% Dynamic Burn-In, Condition D, 240 hrs., +125°C or Equivalent, Method 1015 |
| 100% Constant Acceleration, Method 2001, Condition per Method 5004 | 100% Interim Electrical Test 3 (T3) |
| 100% PIND, Method 2020, Condition A | 100% Delta Calculation (T0-T3) |
| 100% External Visual | 100% PDA 2, Method 5004 (Note 2) |
| 100% Serialization | 100% Final Electrical Test |
| 100% Initial Electrical Test (T0) | 100% Fine/Gross Leak, Method 1014 |
| 100% Static Burn-In 1, Condition A or B, 24 hrs. min., +125°C min., Method 1015 | 100% Radiographic, Method 2012 (Note 3) |
| | 100% External Visual, Method 2009 |
| | Sample - Group A, Method 5005 (Note 4) |
| | 100% Data Package Generation (Note 5) |

NOTES:

1. Failures from Interim electrical test 1 and 2 are combined for determining PDA 1.
2. Failures from subgroup 1, 7, 9 and deltas are used for calculating PDA. The maximum allowable PDA = 5% with no more than 3% of the failures from subgroup 7.
3. Radiographic (X-Ray) inspection may be performed at any point after serialization as allowed by Method 5004.
4. Alternate Group A testing may be performed as allowed by MIL-STD-883, Method 5005.
5. Data Package Contents:
 - Cover Sheet (Intersil Name and/or Logo, P.O. Number, Customer Part Number, Lot Date Code, Intersil Part Number, Lot Number, Quantity).
 - Wafer Lot Acceptance Report (Method 5007). Includes reproductions of SEM photos with percent of step coverage.
 - GAMMA Radiation Report. Contains Cover page, disposition, Rad Dose, Lot Number, Test Package used, Specification Numbers, Test equipment, etc. Radiation Read and Record data on file at Intersil.
 - X-Ray report and film. Includes penetrometer measurements.
 - Screening, Electrical, and Group A attributes (Screening attributes begin after package seal).
 - Lot Serial Number Sheet (Good units serial number and lot number).
 - Variables Data (All Delta operations). Data is identified by serial number. Data header includes lot number and date of test.
 - The Certificate of Conformance is a part of the shipping invoice and is not part of the Data Book. The Certificate of Conformance is signed by an authorized Quality Representative.

AC Timing Diagrams

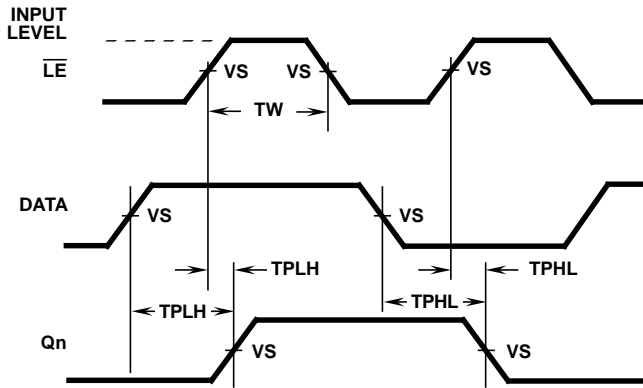

FIGURE 1. DATA AND LATCH ENABLE PROPAGATION DELAYS

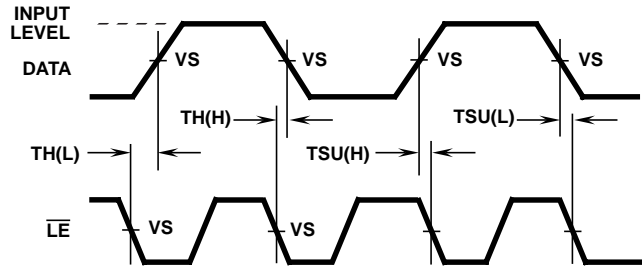

FIGURE 2. LATCH ENABLE PREREQUISITE TIMES

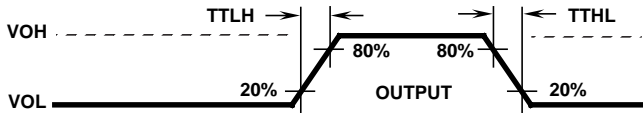
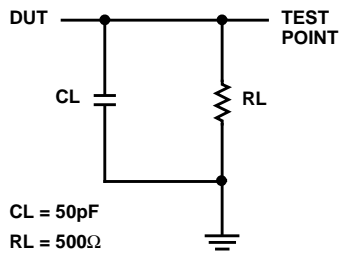

FIGURE 3. DATA SET-UP AND HOLD TIMES

AC VOLTAGE LEVELS

| PARAMETER | HCTS | UNITS |
|-----------|------|-------|
| VCC | 4.50 | V |
| VIH | 3.00 | V |
| VS | 1.30 | V |
| VIL | 0 | V |
| GND | 0 | V |

AC Load Circuit



Three-State Low Timing Diagram

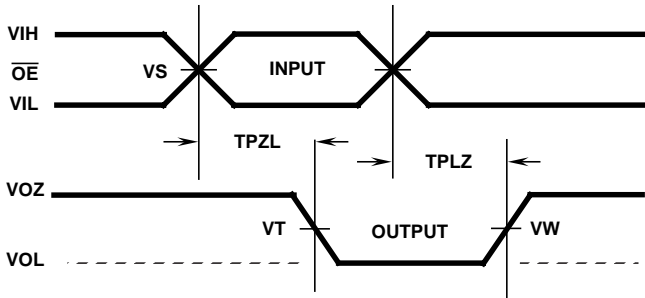

THREE-STATE LOW VOLTAGE LEVELS

| PARAMETER | HCTS | UNITS |
|-----------|------|-------|
| VCC | 4.50 | V |
| VIH | 3.00 | V |
| VS | 1.30 | V |
| VT | 1.30 | V |
| VW | 0.90 | V |
| VIL | 0 | V |
| GND | 0 | V |

Three-State Load Circuit

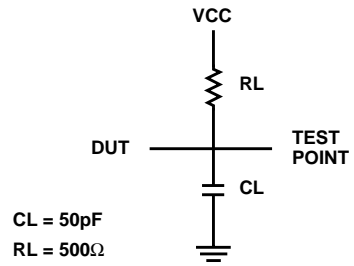

Three-State High Timing Diagram

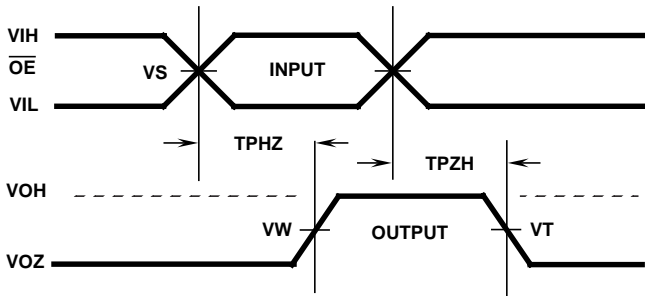

THREE-STATE HIGH VOLTAGE LEVELS

| PARAMETER | HCTS | UNITS |
|-----------|------|-------|
| VCC | 4.50 | V |
| VIH | 3.00 | V |
| VS | 1.30 | V |
| VT | 1.30 | V |
| VW | 3.60 | V |
| VIL | 0 | V |
| GND | 0 | V |

Three-State Load Circuit

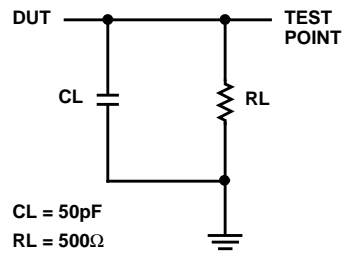

HCTS373MS

Die Characteristics

DIE DIMENSIONS:

108 x 106 mils

METALLIZATION:

Type: SiAl

Metal Thickness: $11\text{k}\text{\AA} \pm 1\text{k}\text{\AA}$

GLASSIVATION:

Type: SiO_2

Thickness: $13\text{k}\text{\AA} \pm 2.6\text{k}\text{\AA}$

WORST CASE CURRENT DENSITY:

$2.0 \times 10^5 \text{A/cm}^2$

BOND PAD SIZE:

$100\mu\text{m} \times 100\mu\text{m}$

4 x 4 mils

Metallization Mask Layout

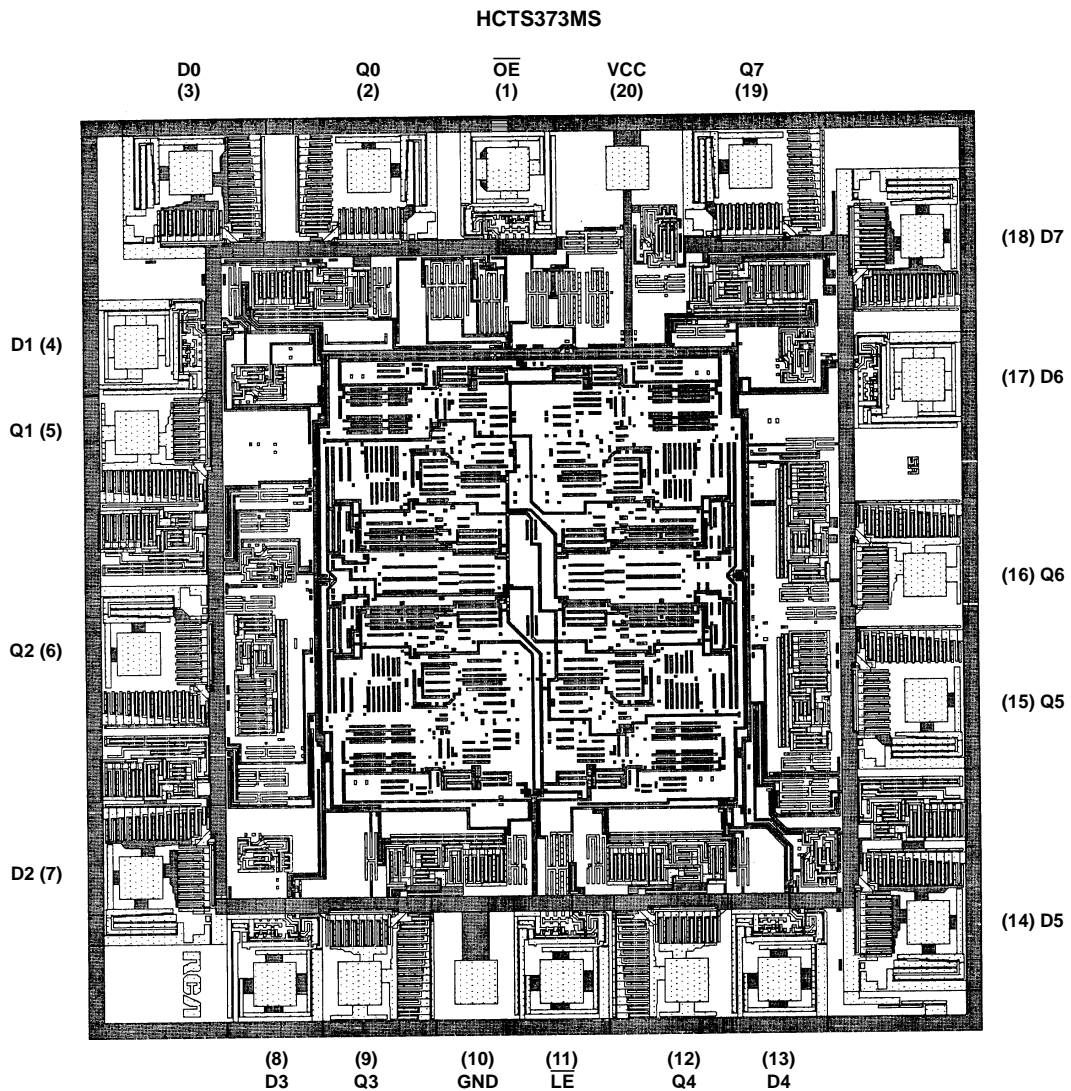

NOTE: The die diagram is a generic plot from a similar HCS device. It is intended to indicate approximate die size and bond pad location. The mask series for the HCTS373 is TA14403A.

All Intersil semiconductor products are manufactured, assembled and tested under **ISO9000** quality systems certification.

Intersil products are sold by description only. Intersil Corporation reserves the right to make changes in circuit design and/or specifications at any time without notice. Accordingly, the reader is cautioned to verify that data sheets are current before placing orders. Information furnished by Intersil is believed to be accurate and reliable. However, no responsibility is assumed by Intersil or its subsidiaries for its use; nor for any infringements of patents or other rights of third parties which may result from its use. No license is granted by implication or otherwise under any patent or patent rights of Intersil or its subsidiaries.

For information regarding Intersil Corporation and its products, see web site <http://www.intersil.com>

Sales Office Headquarters

NORTH AMERICA

Intersil Corporation
P. O. Box 883, Mail Stop 53-204
Melbourne, FL 32902
TEL: (407) 724-7000
FAX: (407) 724-7240

EUROPE

Intersil SA
Mercure Center
100, Rue de la Fusee
1130 Brussels, Belgium
TEL: (32) 2.724.2111
FAX: (32) 2.724.22.05

ASIA

Intersil (Taiwan) Ltd.
Taiwan Limited
7F-6, No. 101 Fu Hsing North Road
Taipei, Taiwan
Republic of China
TEL: (886) 2 2716 9310
FAX: (886) 2 2715 3029